

# Data Sheet



Article number: 021816011252

Description: Clamp with bracket and rubber  
SPGU 6011. 252/30 SK

## Measures

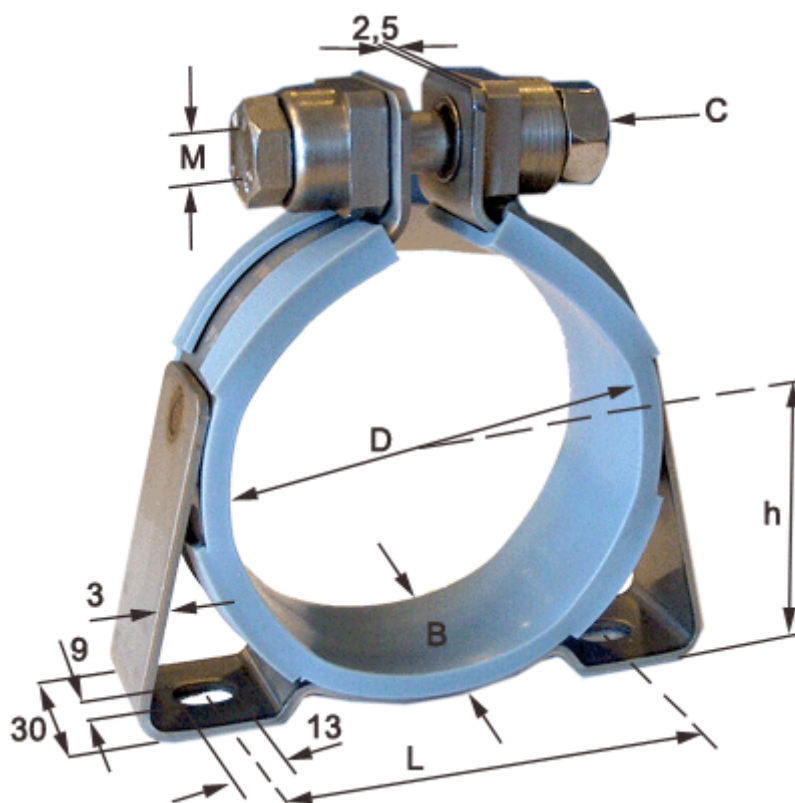

C (screw type) = SK hexagon screw

Diameter D = 252

h = 135

L = 248

Width B = 30